

Руководство по эксплуатации

Полноприводная радиоуправляемая машина
с нитро-двигателем и электродвигателем в
масштабе 1/10

DT5 N1/N2



RH1008 - N1 (одна скорость)

RH1009 - N2 (две скорости)

DT5 EBD/EBL



RH1018 - EBD (коллекторный
двигатель)

RH1019 - EBL (бесколлекторный
двигатель)

RH1008 DT5 N1 (Односкоростная система)

Характеристики RH1001:

1. Длина: 530 мм (N1)
2. Ширина: 290 мм (N1)
3. Высота: 180 мм (N1)
4. Колесная база: 325 мм
5. Передаточное число: 8.3:1
6. Шины: Ø 95*40 мм
7. Вес: 1850 г (N1)

Стандартное оборудование:

1. Рулевой сервопривод: 3 кг/см
2. Сервопривод тяги: 3 кг/см
3. Двигатель: GO.18 или SH.18
4. Радио: 2 канала AM

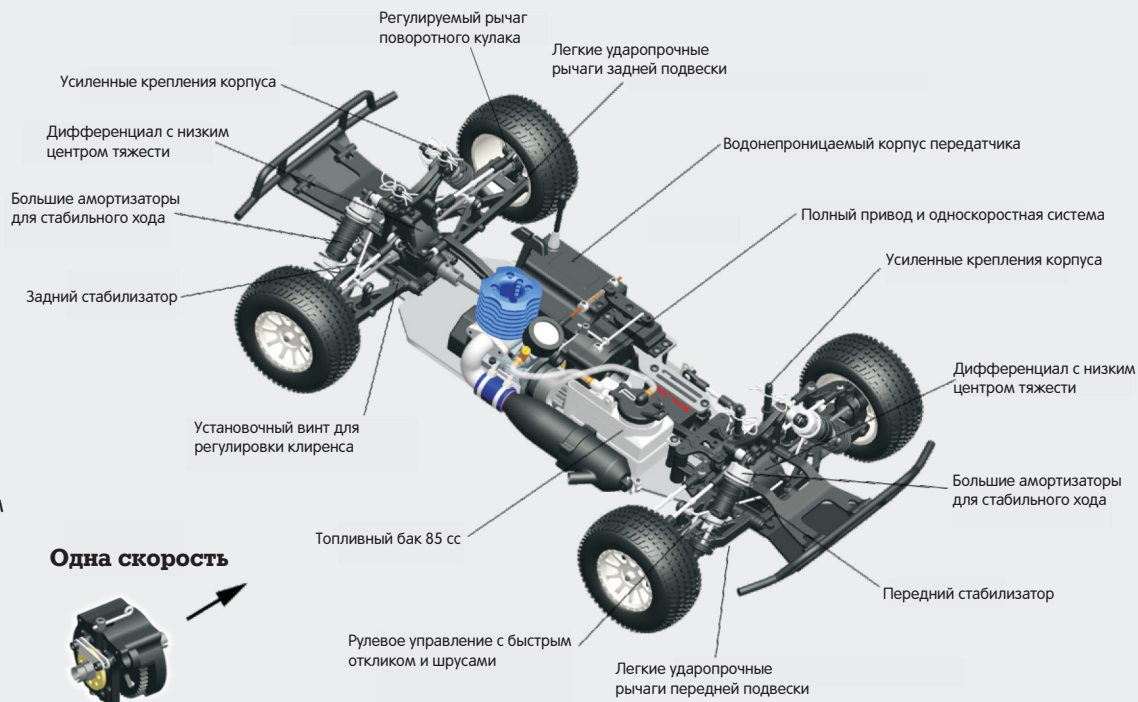

RH1009 DT5 N2 (Двухскоростная система)

Характеристики RH1002:

1. Длина: 530 мм (N2)
2. Ширина: 290 мм (N2)
3. Высота: 180 мм (N2)
4. Колесная база: 325 мм
5. Передаточное число: 6.3:1 (Выс)
9.1:1 (Низк)
6. Шины: Ø 95*40 мм
7. Вес: 1900 г (N2)

Стандартное оборудование:

1. Рулевой сервопривод: 3 кг/см
2. Сервопривод тяги: 3 кг/см
3. Двигатель: GO.18 или SH.18
4. Радио: 2 канала AM

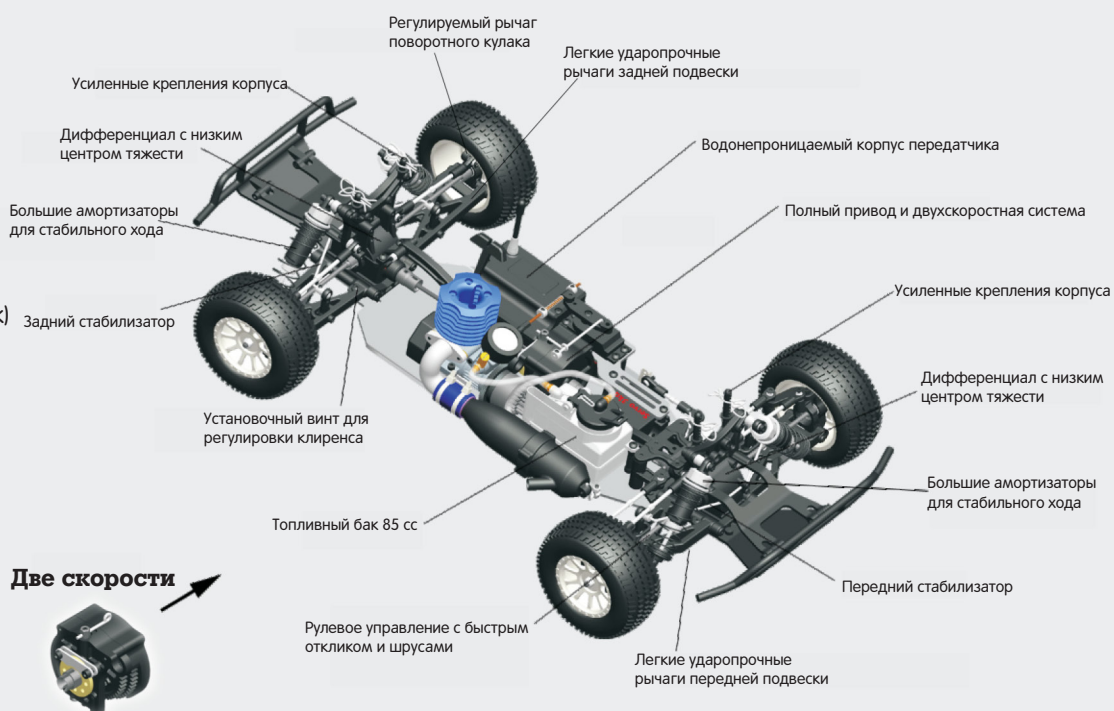

СБОРКА ПЕРЕДНИХ И ЗАДНИХ АМОРТИЗАТОРОВ

Передние амортизаторы

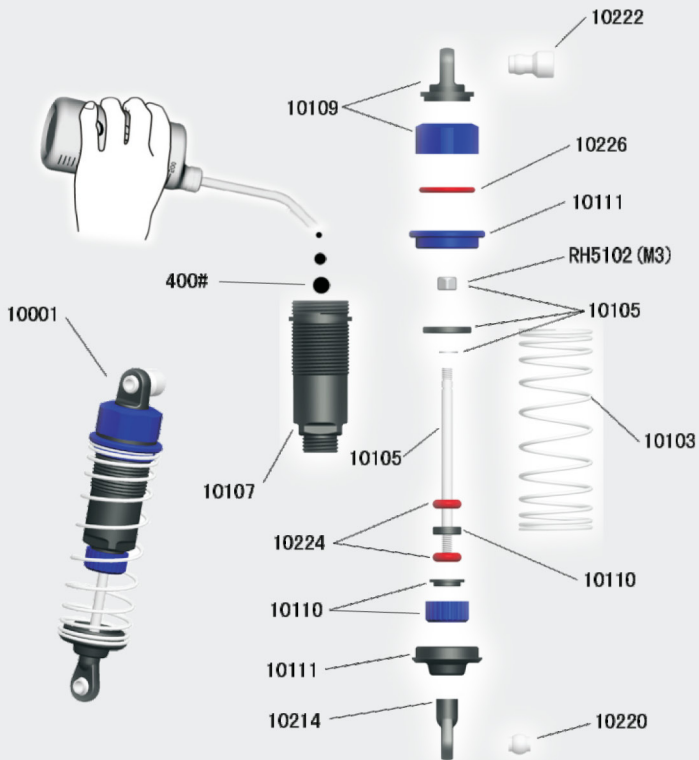

(Схема 3-1)

Задние амортизаторы

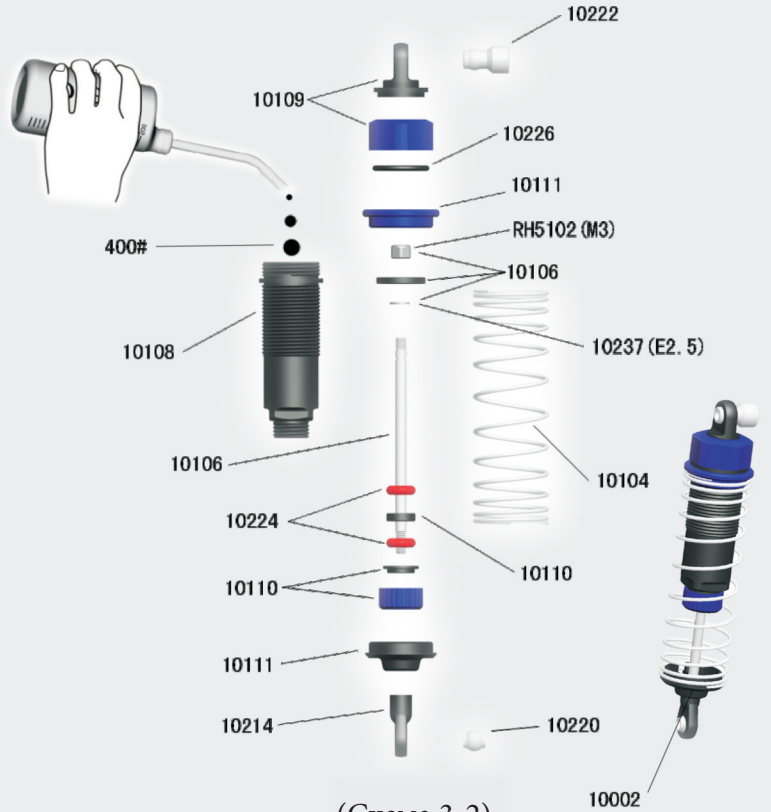

(Схема 3-2)

Сборка шасси

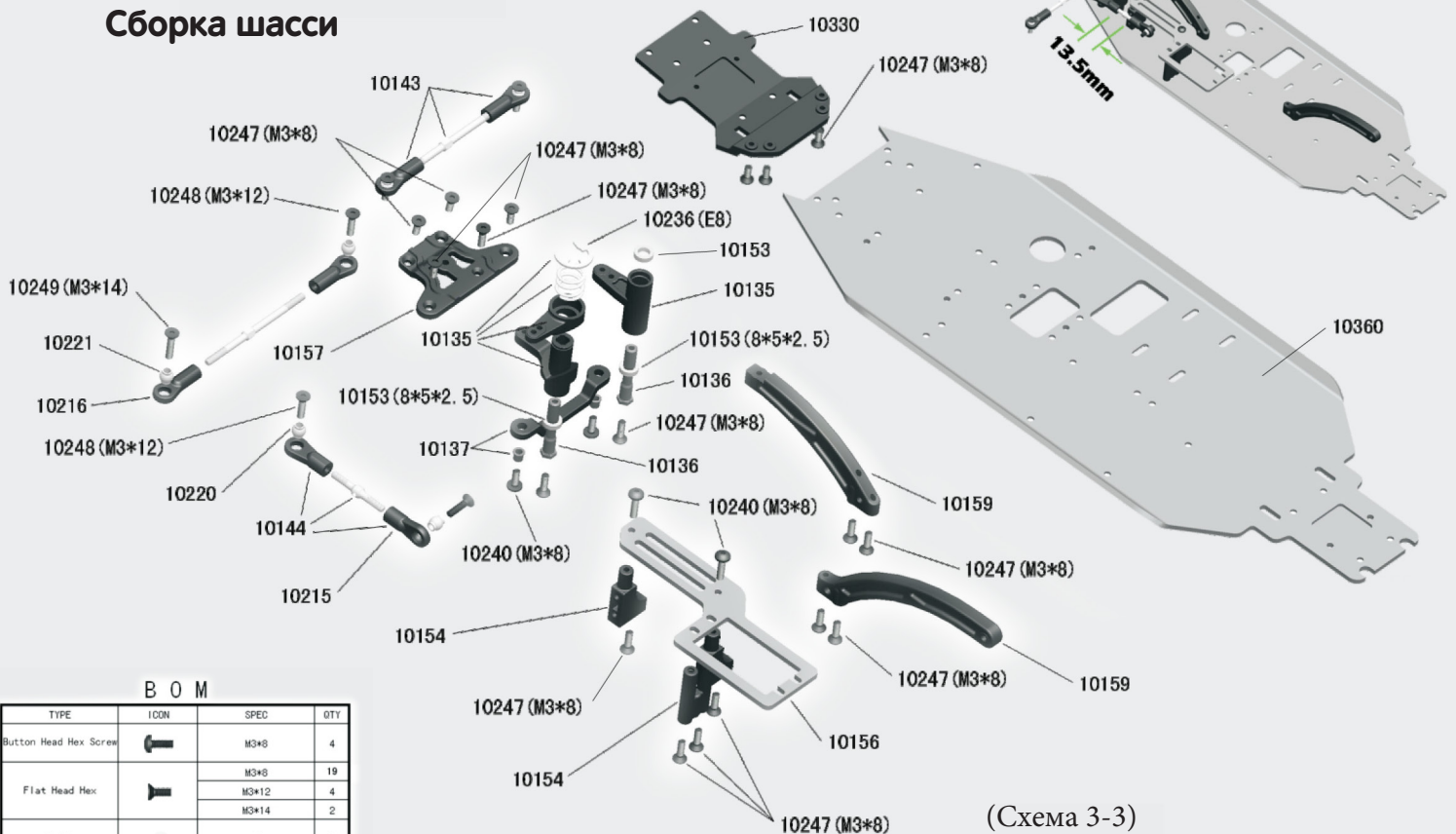

(Схема 3-3)

B O M

TYPE	ICDN	SPEC	QTY
Button Head Hex Screw		M3*8	4
		M3*8	19
		M3*12	4
Flat Head Hex		M3*12	4
		M3*14	2
E clip		ø8	1
Ball Bearing		ø8*ø5*2.5	3

Сборка передней части

B O M

TYPE	ICON	SPEC	QTY
Round Head Self Tapping Hex Screw		2#10	4
Button Head Hex Screw		3#6	4
Cap Head Hex Screw		M3#8	3
		M3#12	2
		M3#8	4
		M3#14	2
		M3#16	2
Flat Head Hex		M3#12	2
		M3#14	2
		M3#18	2
		M3#8	2
		M3#10	10
		M3#12	3
		M3#14	2
Set Screw		M4#4	1
		M4#10	2
		M4#10	2
Ring Self Tapping Screw		3#4	2
Washer		ø6#3, 1#0, 2	2
Nylon Lock Nut		M3	2
E clip		ø2, 5	5
O'Ring		ø8, 05#ø4, 95#ø1, 95	4
		ø8#ø3#ø2, 5	4
		ø15, 6#ø12, 6#ø1, 5	2
Ball Bearing		ø15#ø10#4	2
		ø10#ø5#4	6

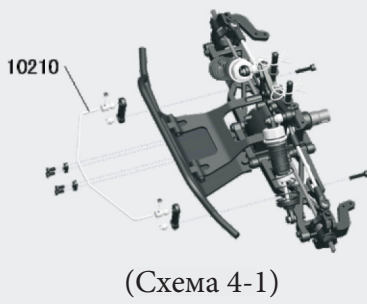
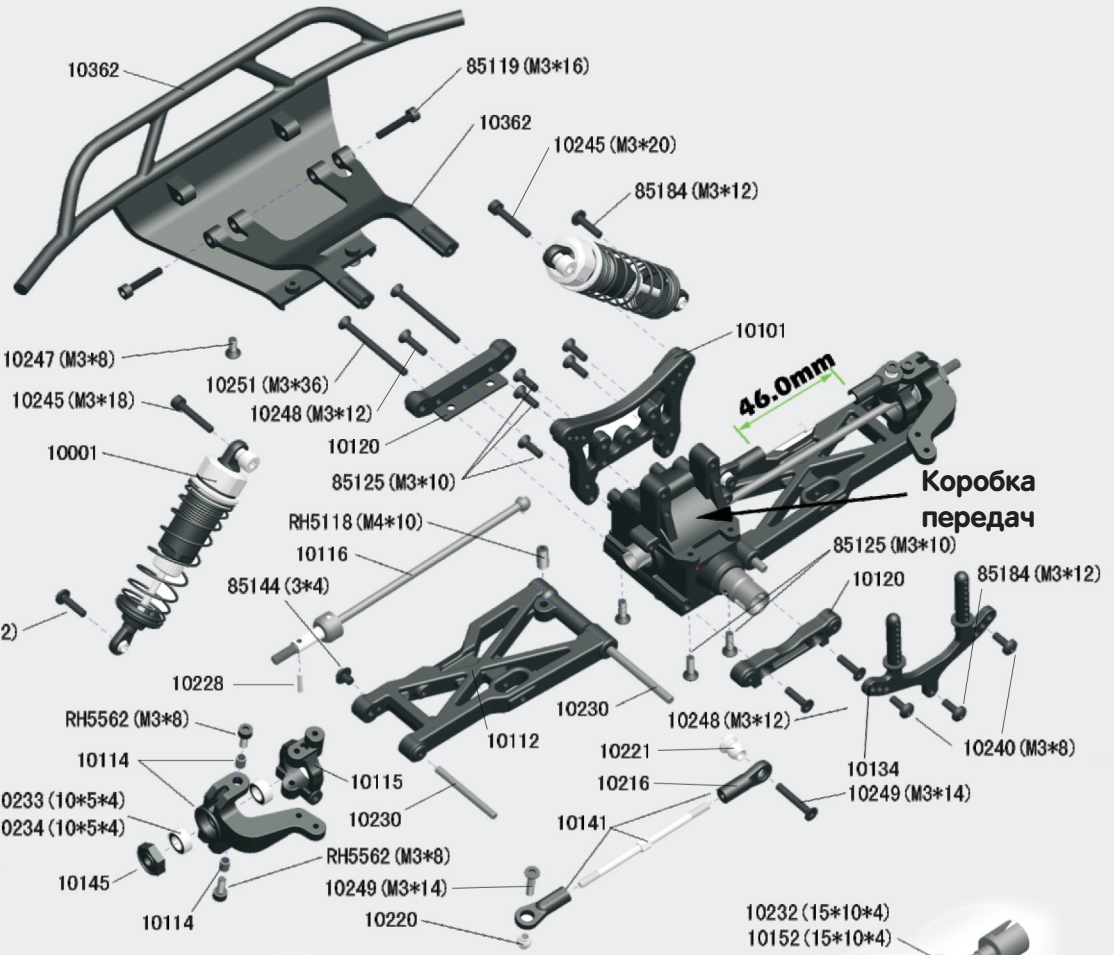

(Схема 4-1)

Сборка коробки передач

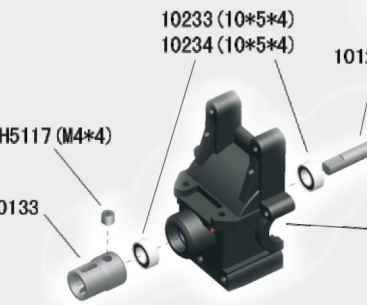

(Схема 4-2)

(Схема 4-3)

Сборка задней части

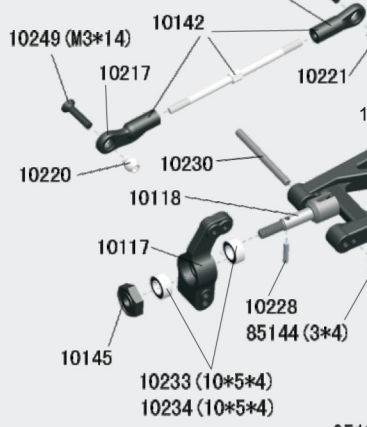
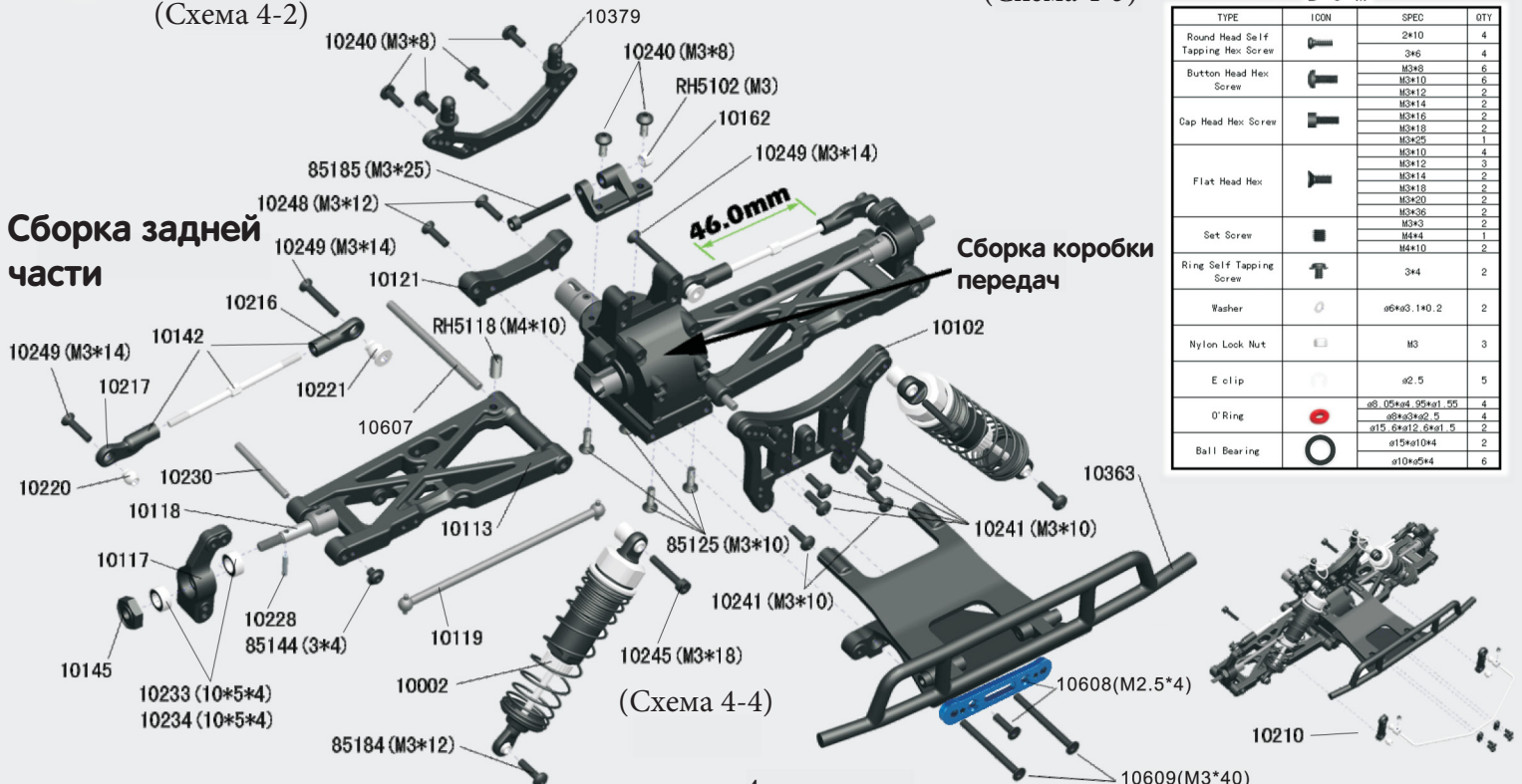

(Схема 4-4)

B O M

TYPE	ICON	SPEC	QTY
Round Head Self Tapping Hex Screw		2#10	4
Button Head Hex Screw		3#6	4
		M3#8	6
		M3#10	6
Cap Head Hex Screw		M3#12	2
		M3#14	2
		M3#16	2
		M3#18	2
		M3#25	1
Flat Head Hex		M3#10	4
		M3#12	3
		M3#14	2
		M3#18	2
		M3#20	2
		M3#36	2
		M3#36	2
Set Screw		M4#4	1
		M4#10	2
		M4#10	2
Ring Self Tapping Screw		3#4	2
Washer		ø6#3, 1#0, 2	2
Nylon Lock Nut		M3	3
E clip		ø2, 5	5
O'Ring		ø8, 05#ø4, 95#ø1, 95	4
		ø8#ø3#ø2, 5	4
		ø15, 6#ø12, 6#ø1, 5	2
Ball Bearing		ø15#ø10#4	2
		ø10#ø5#4	6

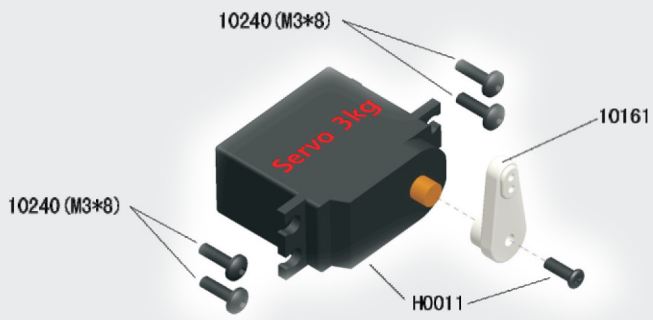

Рулевой сервопривод



(Схема 6-1)

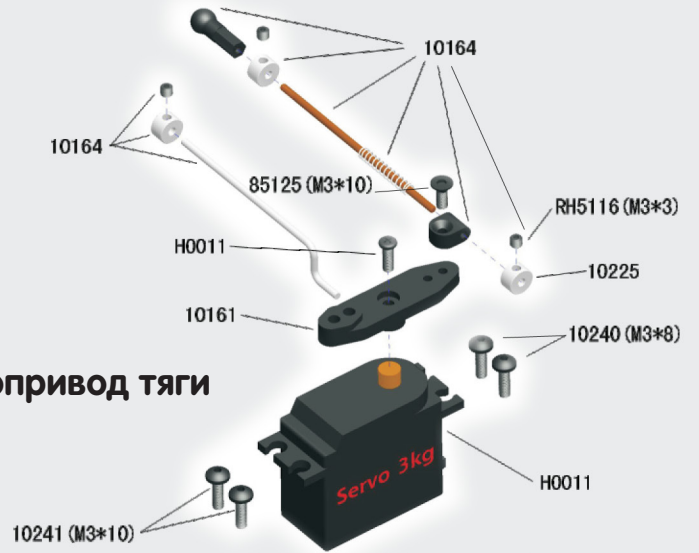

Сервопривод тяги



(Схема 6-2)

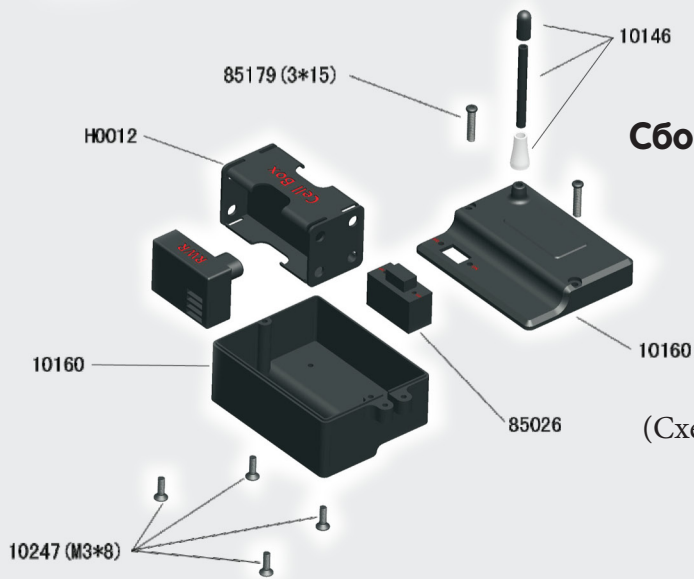

Сборка приемника



(Схема 6-3)

Колеса

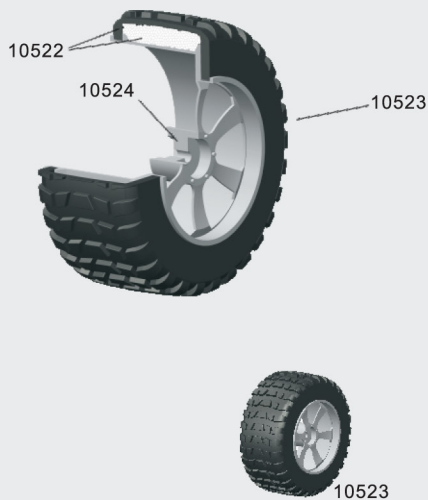

(Схема 6-4)

Топливный бак



(Схема 6-5)

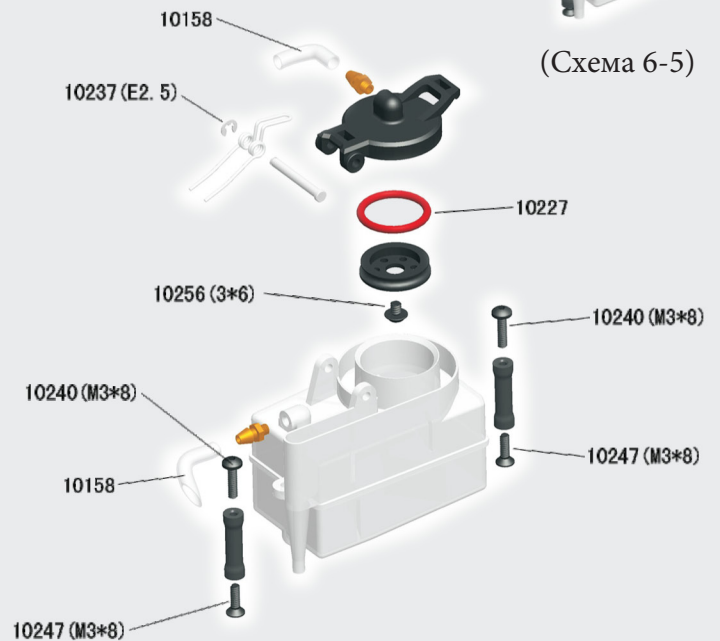

Этапы сборки:

1. Подсоедините стойки топливного бака к шасси, затем соберите топливный бак (см. Схема 6-6)

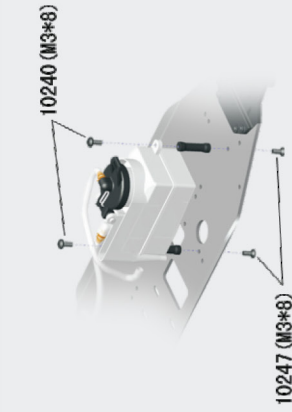

2. Соберите шасси (см. Схема 3-3, 6-1, 6-2)

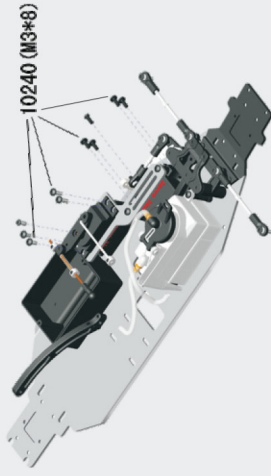

3. Прикрепите к шасси собранную переднюю часть (см. Схема 4-1)



4. Прикрепите к шасси собранную заднюю часть (см. Схема 4-4)



5. Прикрепите колеса (см. Схема 6-4 или 6-5)



6. Прикрепите собранную центральную трансмиссию и задний центральный приводной вал к шасси (см. Схема 5-2 или 5-3)

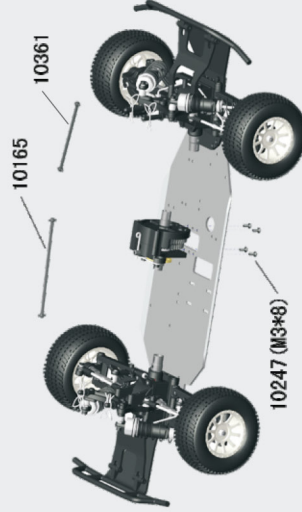

7. Подсоедините собранный двигатель к шасси (см. Схема 5-1)

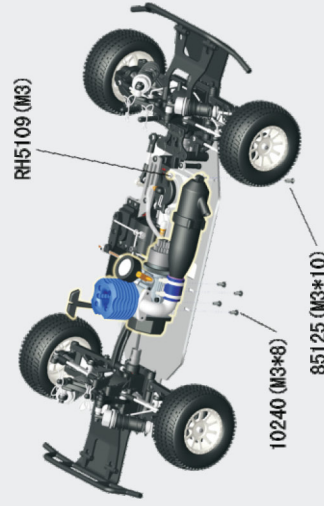

8. И, наконец, подсоедините к шасси коробку приемника, сервоприводы тяги и рулевого управления. Затем настройте систему радиоуправления, после чего прикрепите сверху штампованный корпус к соответствующим креплениям (см. схема 6-3)



Готов к заезду!!



RH1018 DT5 EBD(Коллекторный двигатель)

RH1019 DT5 EBL (Бесколлекторный двигатель)

Характеристики:

1. Длина: 530 мм
2. Ширина: 290 мм
3. Высота: 180 мм
4. Колесная база: 325 мм
5. Передаточное число: 8.3:1
6. Шины: $\varnothing 95 \times 40$ мм
7. Вес: 1950 г

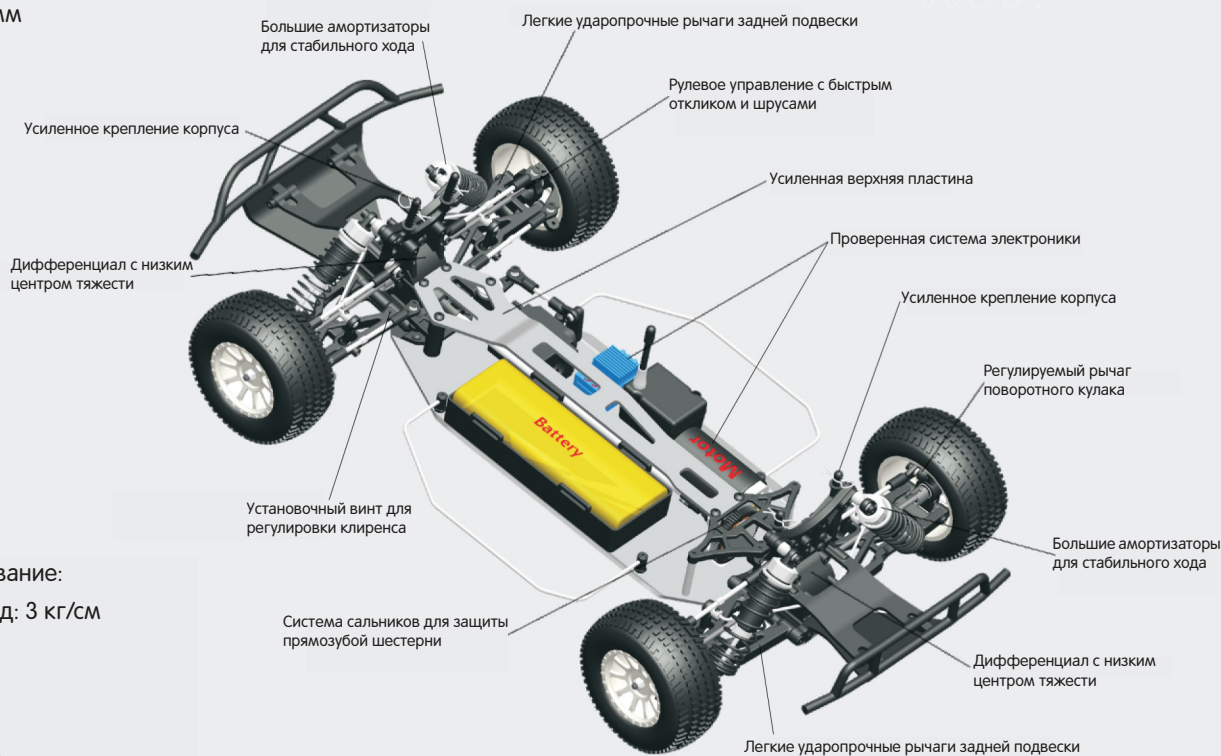

Стандартное оборудование:

1. Рулевой сервопривод: 3 кг/см
2. Мотор: 550 (EBD)
3650 (EBL)
3. ESC: 60A (EBD)
300A (EBL)
4. Батарея: Ni-MH SC1800 mAh 7.2V(EBD)
Li-Po 2700 mAh 7.4V $\leq 25C$ (EBL)
5. Радио: 2 канала AM (EBD)
2 канала 2.4 ГГц (EBL)

Набор для бесколлекторной системы EBL



Набор для коллекторной системы EBD



DT5 EBD и EBL переделаны из DT5 N1 и у них такая же передняя часть (см. Схема 4-1). Задняя часть в точности такая же, как у DT5 N1, и отличается только отсутствием крышки центральной полуоси (см. Схема 9-2).
Внимание: DT5 EBD и DT5 EBL отличаются только ESC, батареей, двигателем, зарядным устройством и радиоуправлением.

Сборка центральной части

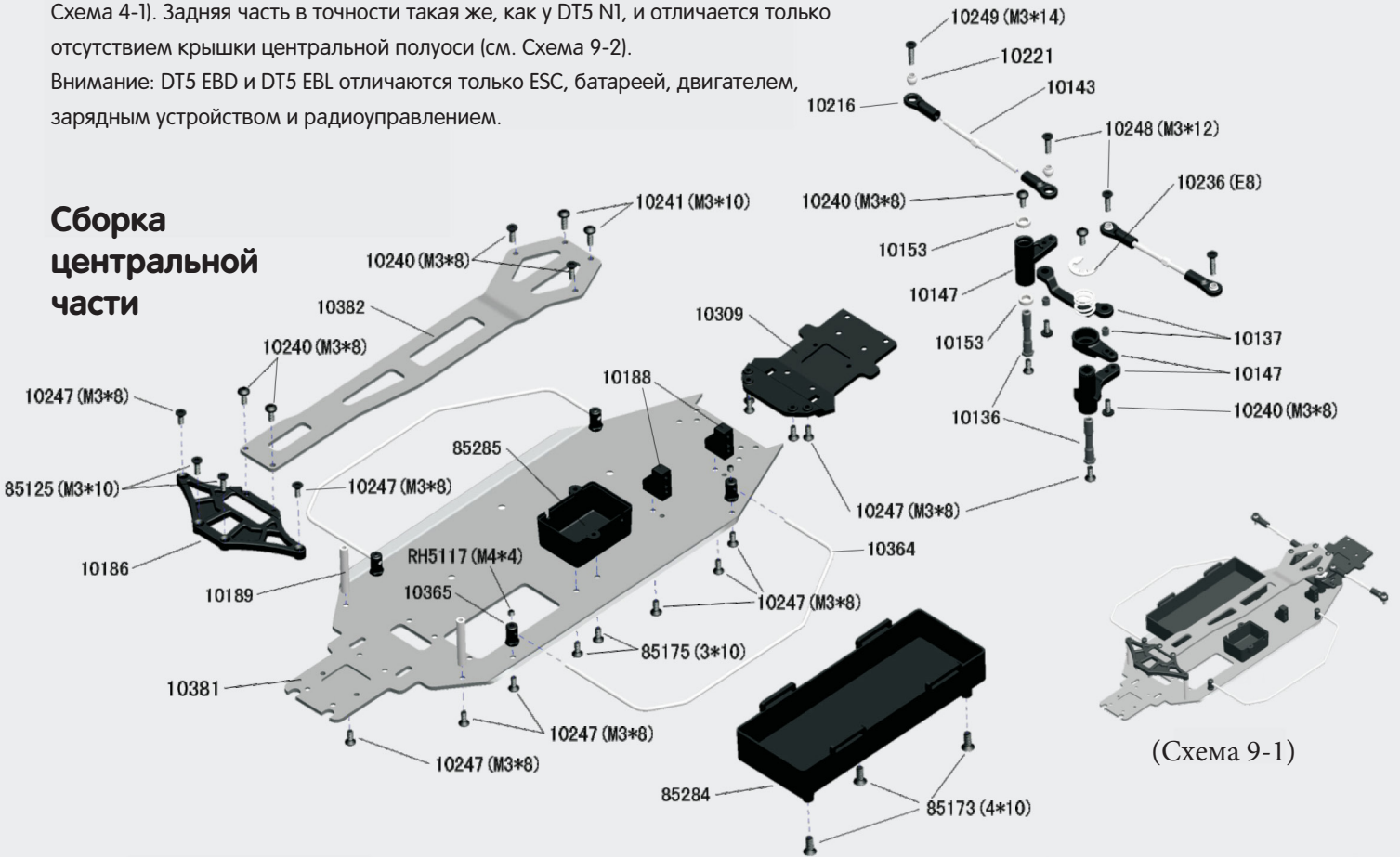

(Схема 9-1)

Сборка задней части



Нет крышки полуоси по сравнению с DT5 N1
(Схема 9-2)

Электронный регулятор оборотов

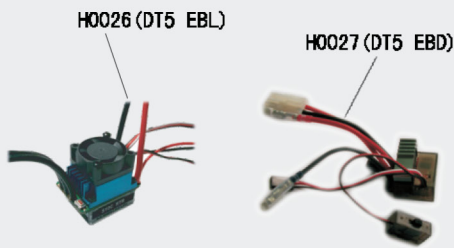

(Схема 9-3)

Сборка рулевого управления



(Схема 9-4)

Сборка мотора

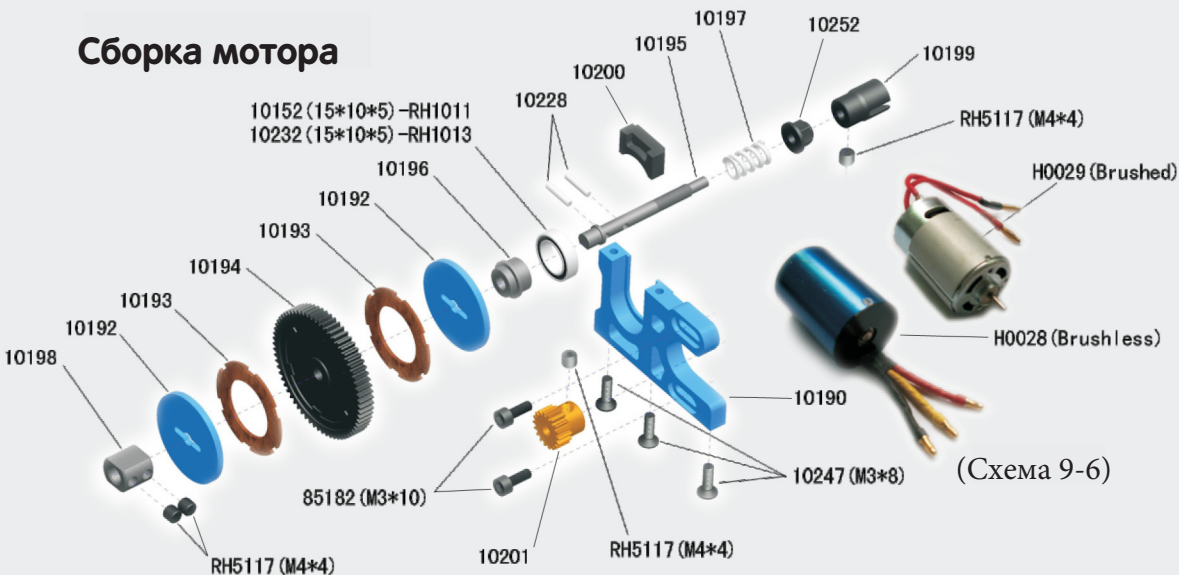

(Схема 9-6)

Приемник



(Схема 9-5)



Этапы сборки:

1. Соберите центральную часть шасси (см. Схема 9-1)

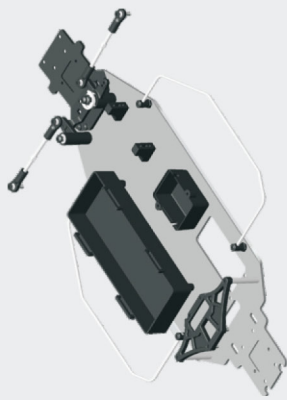

2. Прикрепите к шасси собранную переднюю часть (см. Схема 4-1)



3. Прикрепите к шасси собранную заднюю часть (см. Схема 4-4)



4. Установите колеса (см. Схема 6-4, 6-5)



5. Установите собранный мотор и центральный приводной вал (см. Схема 9-6)

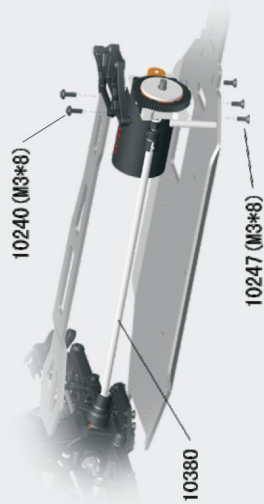

6. Подсоедините рулевой сервопривод и тяги (см. Схема 9-4)



К заезду готов!!!



7. Соберите ESC, приемник, батарею и соедините их (см. Схема 9-3, 9-5).

Бесколлекторная система



Коллекторная система

















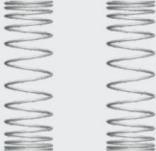





R0092-Printed body(red) 1pc
R0097-Printed body(orange) 1pc
R0092G-Printed body(green) 1pc

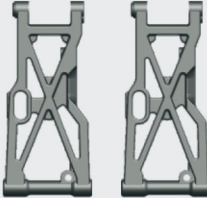
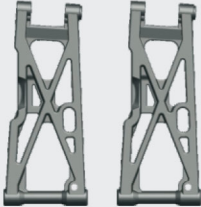



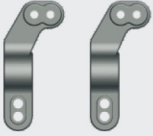
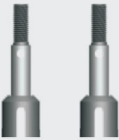

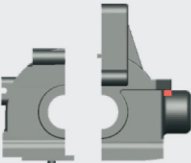

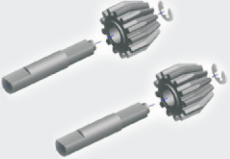



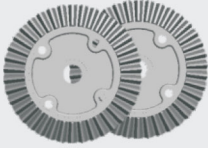
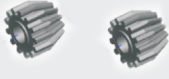
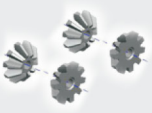
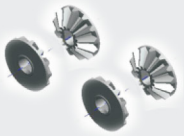



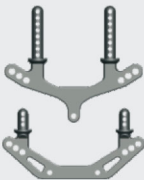

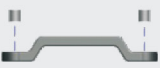
85285

85175 (3*10)

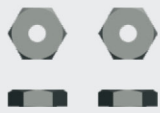
Список деталей

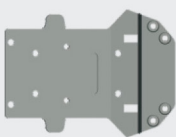
<p>10101 – Front Shock Tower 1pc</p>  <p>RH1008/RH1009/RH1018/RH1019</p>	<p>10102 –Rear Shock Tower 1pc</p>  <p>RH1008/RH1009/RH1018/RH1019</p>	<p>10001–Front Shocks 2pc</p>  <p>RH1008/RH1009/RH1018/RH1019</p>	<p>10002 – Rear Shock Tower 2pc</p>  <p>RH1008/RH1009/RH1018/RH1019</p>
<p>10103–Front Shock Spring 2pc</p>  <p>RH1008/RH1009/RH1018/RH1019</p>	<p>10104–Rear Shock Spring 2pc</p>  <p>RH1008/RH1009/RH1018/RH1019</p>	<p>10105–Front Shock Shaft & Piston Set 2sets</p>  <p>RH1008/RH1009/RH1018/RH1019</p>	<p>10106–Rear Shock Shaft & Piston Set 2sets</p>  <p>RH1008/RH1009/RH1018/RH1019</p>
<p>10107–Front Shock Body 2pc</p>  <p>RH1008/RH1009/RH1018/RH1019</p>	<p>10108–Rear Shock body 2pc</p>  <p>RH1008/RH1009/RH1018/RH1019</p>	<p>10109–Shock Upper Cap 2sets</p>  <p>RH1008/RH1009/RH1018/RH1019</p>	<p>10110–Shock Lower Caps 2sets</p>  <p>RH1008/RH1009/RH1018/RH1019</p>
<p>10111–Shock Lower holder & Adjust Ring 2sets</p>  <p>RH1008/RH1009/RH1018/RH1019</p>	<p>10112–Front Lower Susp. Arm 2pc</p>  <p>RH1008/RH1009/RH1018/RH1019</p>	<p>10113–Rear Lower Susp. Arm 2pc</p>  <p>RH1008/RH1009/RH1018/RH1019</p>	<p>10114–Steering Knuckle Arm 1set</p>  <p>RH1008/RH1009/RH1018/RH1019</p>
<p>10115–Uprights 2pc</p>  <p>RH1008/RH1009/RH1018/RH1019</p>	<p>10116–Front CVD 2pc</p>  <p>RH1008/RH1009/RH1018/RH1019</p>	<p>10117–Rear Hub Carrier 2pc</p>  <p>RH1008/RH1009/RH1018/RH1019</p>	<p>10118–Rear Drive Shaft 2pc</p>  <p>RH1008/RH1009/RH1018/RH1019</p>
<p>10119–Rear Dogbones 2pc</p>  <p>RH1008/RH1009/RH1018/RH1019</p>	<p>10123–Gearbox Housing Set 2pcs</p>  <p>RH1008/RH1009/RH1018/RH1019</p>	<p>RH5526–Diff 16T Gear Washer 6pcs</p>  <p>RH1008/RH1009/RH1018/RH1019</p>	<p>10124–Diff. Drive Gear w/pin 2sets</p>  <p>RH1008/RH1009/RH1018/RH1019</p>









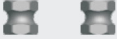

Список деталей

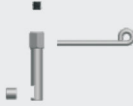
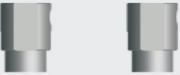
<p>10125-Diff Case 2pcs</p>  <p>RH1008/RH1009/RH1018/RH1019</p>	<p>10126-Diff Drive Spur Gear 2pcs</p>  <p>RH1008/RH1009/RH1018/RH1019</p>	<p>10127-Diff Drive Gear 2pcs</p>  <p>RH1008/RH1009/RH1018/RH1019</p>	<p>10128-Diff Bevel Gear S. 4pcs</p>  <p>RH1008/RH1009/RH1018/RH1019</p>
<p>10129-Diff Bevel Gear B. 4pcs</p>  <p>RH1008/RH1009/RH1018/RH1019</p>	<p>10130-Diff Pin 2pcs</p>  <p>RH1008/RH1009/RH1018/RH1019</p>	<p>10131-Washer 6pcs</p>  <p>RH1008/RH1009/RH1018/RH1019</p>	<p>10132-Diff Drive Cup 4pcs</p>  <p>RH1008/RH1009/RH1018/RH1019</p>
<p>10133-Center Coupler 3pcs</p>  <p>RH1008/RH1009/RH1018/RH1019</p>	<p>10379-Body Post 2pcs</p>  <p>RH1008/RH1009/RH1018/RH1019</p>	<p>10135-Servo Saver (GP) 1set</p>  <p>RH1008/RH1009</p>	<p>10136-Servo Saver Post 2pcs</p>  <p>RH1008/RH1009/RH1018/RH1019</p>
<p>10137-Steering Ackerman</p>  <p>RH1008/RH1009/RH1018/RH1019</p>	<p>10141-Front Upper Susp. Arm 2sets</p>  <p>RH1008/RH1009/RH1018/RH1019</p>	<p>10142-Rear Upper Susp. Arm 2sets</p>  <p>RH1008/RH1009/RH1018/RH1019</p>	<p>10143-Steering Arm 2sets</p>  <p>RH1008/RH1009/RH1018/RH1019</p>
<p>10144-Servo Linkage 1pc</p>  <p>RH1008/RH1009/RH1018/RH1019</p>	<p>10145-Wheel Hub 4pcs</p>  <p>RH1008/RH1009/RH1018/RH1019</p>	<p>10146-Antenna Pipe Set 2sets</p>  <p>RH1008/RH1009/RH1018/RH1019</p>	<p>10147-Servo Saver (EP) 1set</p>  <p>RH1018/RH1019</p>
<p>10330-Chassis Front Part 1pc</p>  <p>RH1008/RH1009/RH1018/RH1019</p>	<p>10522-Tyre & insert 2sets</p>  <p>RH1008/RH1009/RH1018/RH1019</p>	<p>10523-Wheel complete 2sets</p>  <p>RH1008/RH1009/RH1018/RH1019</p>	<p>10524-Rim 2pcs</p>  <p>RH1008/RH1009/RH1018/RH1019</p>







Список деталей

<p>10362-Front bumper Set 1set</p>  <p>RH1008/RH1009/RH1018/RH1019</p>	<p>10363-Rear bumper Set 1set</p>  <p>RH1008/RH1009/RH1018/RH1019</p>	<p>10003-Diff Gearbox Set 1set</p>  <p>RH1008/RH1009/RH1018/RH1019</p>	<p>10607-Rear susp. arm pins w/screws</p> 
<p>10151-Manifold Gasket 6pc</p>  <p>RH1008/RH1009</p>	<p>10152-Metal Bushing 15*10*4 6pc</p> 	<p>10153-Metal Bushing 8*5*2.5 6pc</p> 	<p>10154-Servo & Upper Plate Mounts 1set</p>  <p>RH1008/RH1009</p>
<p>10156-Upper Plate 1pc</p>  <p>RH1008/RH1009</p>	<p>10157-Upper Steering Plate</p>  <p>RH1008/RH1009</p>	<p>10004-Fuel tank Set 1set</p>  <p>RH1008/RH1009</p>	<p>10158-Fuel Line 2pcs</p>  <p>RH1008/RH1009</p>
<p>10159-Front/Rear Chassis Brace</p>  <p>RH1008/RH1009</p>	<p>10160-Receiver Box 1set</p>  <p>RH1008/RH1009</p>	<p>85026-Switch Cover 2pcs</p>  <p>RH1008/RH1009</p>	<p>10161-Servo Horns</p>  <p>RH1008/RH1009</p>
<p>10162-Chassis Brace mount 1pc</p>  <p>RH1008/RH1009</p>	<p>10163-Stopper 6pcs</p>  <p>RH1008/RH1009</p>	<p>10164-Throttle Linkage 1set</p>  <p>RH1008/RH1009</p>	<p>10165-Central Dongbone F. 1pc</p>  <p>RH1008/RH1009</p>
<p>P0010-G0. 18 engine 1pc P0011-SH. 18 Engine 1pc</p>  <p>RH1008/RH1009</p>	<p>10167-Air filter 1Set</p>  <p>RH1008/RH1009</p>	<p>10168-Tuned Pipe 1Set</p>  <p>RH1008/RH1009</p>	<p>10169-Silicone Coupler 1Set</p>  <p>RH1008/RH1009</p>











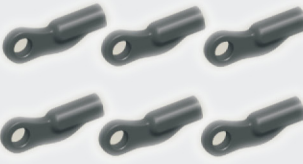





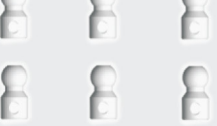

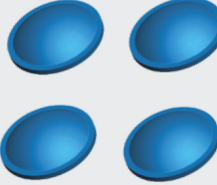



Список деталей

<p>85195-Zip Tie 6pcs</p>  <p>RH1008/RH1009/RH1018/RH1019</p>	<p>10170-Manifold 1Set</p>  <p>RH1008/RH1009</p>	<p>85035-Flywheel 1pc</p>  <p>RH1008/RH1009</p>	<p>85087-Clutch Nut 2pcs</p>  <p>RH1008/RH1009</p>
<p>85045-Clutch Shoes & Springs</p>  <p>RH1008/RH1009</p>	<p>10171-Clutch Bell (14T) 1pc</p>  <p>RH1008</p>	<p>10172-Clutch Bell (two speed) 1pc</p>  <p>RH1009</p>	<p>10173-Engine mount 2pcs</p>  <p>RH1008/RH1009</p>
<p>10005-Central Transmission Complete 1Set (Single Speed)</p>  <p>RH1008</p>	<p>10174-Central Transmission Bulkheads 2pcs</p>  <p>RH1008/RH1009</p>	<p>10175-Brake Post 1Set</p>  <p>RH1008/RH1009</p>	<p>10176-Brake Set 1set</p>  <p>RH1008/RH1009</p>
<p>10177-Brake Cup 2pcs</p>  <p>RH1008/RH1009</p>	<p>10178-Single Speed Shaft w/pin</p>  <p>RH1008</p>	<p>10179-50T Gear (Single Speed) 1pc</p>  <p>RH1008</p>	<p>10006-Central Transmission Complete 1Set (Two Speed)</p>  <p>RH1009</p>
<p>10180-Two Speed Clutch 1Set</p>  <p>RH1009</p>	<p>10181-Two Speed Shaft 1pc</p>  <p>RH1009</p>	<p>10182-50T Two Speed Gear 1pc</p>  <p>RH1009</p>	<p>10183-45T Two Speed Gear 1pc</p>  <p>RH1009</p>
<p>10360-N1/N2 Chassis Plate 1pc</p>  <p>RH1008/RH1009</p>	<p>10361-Central Dongbone R. 1pc</p>  <p>RH1008/RH1009</p>	<p>10185-Battery Cover (EP) 1pc</p>  <p>RH1018/RH1019</p>	<p>10188-Battery Post 2sets</p>  <p>RH1018/RH1019</p>











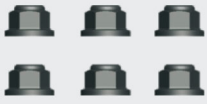







Список деталей

<p>10189-Post for Rear Spur Gear Cover 2pc</p>  <p>RH1018/RH1019</p>	<p>10190-Motor Mount (EP) 1pc</p>  <p>RH1018/RH1019</p>	<p>10191-Slipper Complete (EP) 1set</p>  <p>RH1018/RH1019</p>	<p>10192-Slipper Pad (EP) 2pc</p>  <p>RH1018/RH1019</p>
<p>10193-Slipper Gasket (EP) 2pc</p>  <p>RH1018/RH1019</p>	<p>10194-65T Spur Gear (EP) 1pc</p>  <p>RH1018/RH1019</p>	<p>10195P- Slipper Shaft (EP) 1pc</p>  <p>RH1018/RH1019</p>	<p>10196-Slipper Spring Bracket (EP) 1pc</p>  <p>RH1018/RH1019</p>
<p>10197-Slipper Spring (EP) 1pc</p>  <p>RH1018/RH1019</p>	<p>10198-Slipper Coupler (EP) 1pc</p>  <p>RH1018/RH1019</p>	<p>10199-Slipper Drive Cup 1pc</p>  <p>RH1018/RH1019</p>	<p>10200-BEARING BRACKET (EP) 1pc</p>  <p>RH1018/RH1019</p>
<p>10201-Pinion Gear 17T (EP) 1pc</p>  <p>RH1018/RH1019</p>	<p>10608-Rear bumper fix plate w/screw</p> 	<p>10210-Sway Bar 2Sets</p>  <p>RH1018/RH1019</p>	<p>10364-Body guard frame 2pcs</p>  <p>RH1018/RH1019</p>
<p>10365-Body guard frame bracket 4pcs</p>  <p>RH1018/RH1019</p>	<p>10380-Center Drive Shaft (EP) 1pc</p>  <p>RH1018/RH1019</p>	<p>10381-EBD/EBL chassis plate 1pc</p>  <p>RH1018/RH1019</p>	<p>10382-EBD/EBL upper plate 1pc</p>  <p>RH1018/RH1019</p>
<p>85034-Body Clip (Medium Size) 6pcs</p> 	<p>85029-Body Clip (Small Size) 6pcs</p> 	<p>10214-Shock Ball End 6pcs</p> 	<p>10215-Servo Link Ball End 6pcs</p> 

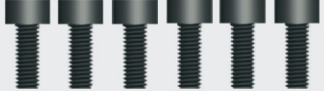
Список деталей

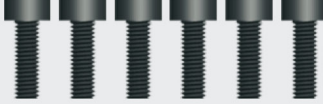
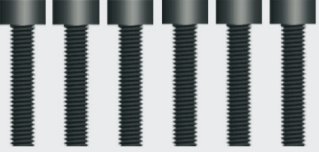
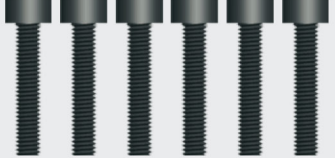
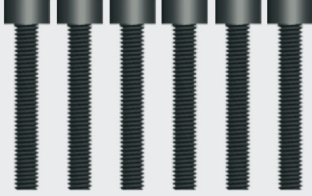
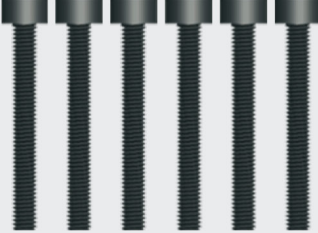
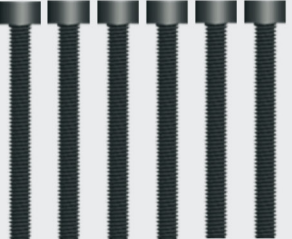
<p>10216-Steering Linkage Ball End 6pcs</p> 	<p>10217-Rear Upper Linkage Ball End 6pcs</p> 	<p>10218-Sway Bar Fix Plate 6pcs</p> 	<p>10219-Sway Bar Holders 6pcs</p> 
<p>10220-Ball A 6pcs</p> 	<p>10221-Ball B 6pcs</p> 	<p>10222-Ball C 6pcs</p> 	<p>10223-Ball D 6pcs</p> 
<p>10224-Shock O-ring(Lower) 6pcs</p> 	<p>10225-Diff O-ring Seal 6pcs</p> 	<p>10226-Shock Seal Cover 4pcs</p> 	<p>10227-Tuned Pipe Seal & Fuel Tank Seal 1set</p> 
<p>10228-Pin ϕ 2*10 6pcs</p> 	<p>10229-Pin ϕ 2*11 6pcs</p> 	<p>10230-Hinge Pins(long & short) 2sets</p> 	<p>10231-One Way Bearing 3pcs</p> 
<p>10232-Ball Bearing 15*10*4 6pcs</p> 	<p>10233-Ball Bearing 10*5*4 6pcs</p> 	<p>10234-Metal Bushing 10*5*4 6pcs</p> 	<p>10235-Ball Bearing 8*5*2.5 6pcs</p> 
<p>10236-E clip-8mm 4pc</p> 	<p>RH5190-E clip-4mm 6pc</p> 	<p>10237-E clip-2.5mm 6pc</p> 	<p>RH5102-Nylon Lock Nut M3 6pc</p> 

Список деталей

<p>RH5103-Nylon Lock Nut-M4 6pc</p> 	<p>85148-Round Head Self Tapping Hex Screw 2*6 4pcs</p> 	<p>10238-Round Head Self Tapping Hex Screw 2*10 6pc</p> 	<p>85179-Round Head Self Tapping Hex Screw 3*15 8pc</p> 
<p>10239-Round Head Self Tapping Hex Screw M3*6 6pc</p> 	<p>10240-Button Head Hex Screw M3*8 6pc</p> 	<p>10241-Button Head Hex Screw M3*10 6pc</p> 	<p>85184-Button Head Hex Screw M3*12 6pc</p> 
<p>10242-Button Head Hex Screw M3*14 6pc</p> 	<p>85144-Ring Self Tapping Screw 3*4 4pc 10256-Ring Self Tapping Screw 3*6 6pc</p> 	<p>RH5116-Set Screw M3*3 6pc</p> 	<p>RH5117-Set Screw M4*4 6pc</p> 
<p>RH5118-Button Head Hex Screw M4*10 6pc</p> 	<p>RH5562-Cap Head Hex Screw M3*8 6pc</p> 	<p>10243-Cap Head Hex Screw M3*10 6pc</p> 	<p>85182-Cap Head Hex Screw M3*10 6pc</p> 
<p>10244-Cap Head Hex Screw M3*14 6pc</p> 	<p>85119-Cap Head Hex Screw M3*16 6pc</p> 	<p>10245-Cap Head Hex Screw M3*18 6pc</p> 	<p>85185-Cap Head Hex Screw M3*25 6pc</p> 
<p>10246-Cap Head Hex Screw M3*28 6pc</p> 	<p>10247-Flat Head Hex M3*8 6pc</p> 	<p>85125-Flat Head Hex Screw M3*10 8pc</p> 	<p>85175-Flat Head Hex Screw 3*10 8pc</p> 

Список деталей

<p>10248-Flat Head Hex Screw M3*12 6p</p> 	<p>10249-Flat Head Hex Screw M3*14 6p</p> 	<p>85127-Flat Head Hex Screw M3*18 3p</p> 	<p>10250-Flat Head Hex Screw M3*20 6p</p> 
<p>10251-Flat Head Hex Screw M3*36 6p</p> 	<p>85173-Flat Head Hex Screw M4*10 6p</p> 	<p>H0068-2.4G FS GT2 TX+RX H0068RX-FS Gt2 RX 1pc</p> 	<p>RH5189 - Receiver Switch 1pc</p> 
<p>H0026 - Brushless ESC 1pc</p> 	<p>H0027-300A ESC 1pc</p> 	<p>H0028 - 3650 Brushless Motor 1pc</p> 	<p>H0029 - 550 Brushed Motor 1pc</p> 
<p>H0030 - Ni-MH 7.2V 1800mAh 1pc H0031 - Ni-MH 7.2V 3000mAh 1pc</p> 	<p>H0012 - Battery Case 1pc</p> 	<p>H0011 - 3kg/cm Servo 1pc</p> 	<p>85274-Li-Po 2700mAh 7.4V 1pc</p> 
<p>10253 - 1/10 Charger CE 1pc 10254 - 1/10 Charger UL 1pc 10255 - 1/10 Charger BS 1pc</p> 	<p>85284-Battery case 1pc</p> 	<p>85285-RX case 1set</p> 	<p>10609-Flat Hex Screw M3*40 6pcs</p> 
<p>10610-Rear bumper fix plate & susp. arm pins set</p> 	<p>R0078-Clear SC trusk body 1pc R0079-Printed SC trusk body 1pc</p> 	<p>R0092-Printed body(red)1pc R0097-Printed body(orange)1pc R0092G-Printed body(green) 1pc R0092C-Clear body 1pc</p> 	

Список модернизированных деталей

<p>10902 - Front Shock Plate (Carbon) 1Set</p>  <p>RH1008/RH1009/RH1018/RH1019</p>	<p>10903 - Rear Shock Plate (Carbon) 1Set</p>  <p>RH1008/RH1009/RH1018/RH1019</p>	<p>10906-Body Post (AL) 2pc</p>  <p>RH1018/RH1019</p>	<p>10907-Front Shocks (AL) 2pc</p>  <p>RH1008/RH1009/RH1018/RH1019</p>
<p>10908-Rear Shocks (AL) 2pc</p>  <p>RH1008/RH1009/RH1018/RH1019</p>	<p>10909 - Front Lower Susp. Arm (AL) 2pc</p>  <p>RH1008/RH1009/RH1018/RH1019</p>	<p>10910 -Rear Lower Susp. Arm (AL) 2pc</p>  <p>RH1008/RH1009/RH1018/RH1019</p>	<p>10911 - Steering Ackerman (AL) 1pc</p>  <p>RH1008/RH1009/RH1018/RH1019</p>
<p>10912 - Front Susp. Holders (AL) 1Set</p>  <p>RH1008/RH1009/RH1018/RH1019</p>	<p>10913 - Front & Rear Brace (AL) 1Set</p>  <p>RH1008/RH1009</p>	<p>10914 - Rear Susp. Holders (AL) 1Set</p>  <p>RH1008/RH1009/RH1018/RH1019</p>	<p>10915 - Rear Hub Carrier (AL) 2pc</p>  <p>RH1008/RH1009/RH1018/RH1019</p>
<p>10916-Front Top Plate (Carbon) 1pc</p>  <p>RH1008/RH1009</p>	<p>10917 - Steering Knuckle Arm (AL) 2Set</p>  <p>RH1008/RH1009/RH1018/RH1019</p>	<p>10918 - Wheel Hub (AL) 4pc</p>  <p>RH1008/RH1009/RH1018/RH1019</p>	<p>10919 - Upper Plate (AL) 1pc</p>  <p>RH1008/RH1009</p>
<p>10920 - Tuned Pipe (AL) 1Set</p>  <p>RH1008/RH1009</p>	<p>10921 - Chassis Brace mount (AL) 1pc</p>  <p>RH1008/RH1009</p>	<p>85265 - Heatsink 1pc</p>  <p>RH1018/RH1019</p>	<p>10923 - Alum Steering Arm 2pc</p>  <p>RH1008/RH1009/RH1018/RH1019</p>
<p>10924 - Alum Knuckle Arm 2pc</p>  <p>RH1008/RH1009/RH1018/RH1019</p>	<p>10969-Alloy front suspension holders 1set</p> 	<p>10970-Alloy rear susp. holders 1set</p> 	